



Fixture Type
Materials
Finish

Exterior Steplight
Brass
Natural
*consult factory for other finishes

Lamp Type
Lamp Quantity
Lamp Included
Wattage
Input Voltage
Delivered Lumens
Kelvin
CRI
Power S Type
Power S Quantity
Power S Location
Dimming Type

LED
1
Yes
6W
11-15V
34
2700K
61
Driver
1
Remote
ELV

Designer

Holm

Listings

UL
WET

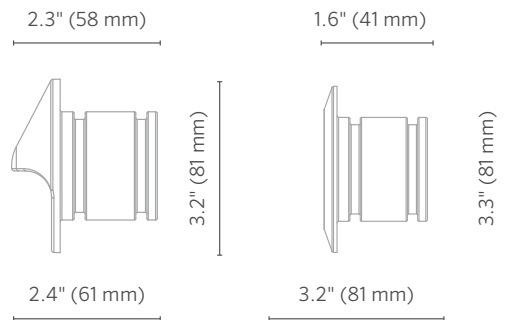



Round



Spot

Output	1LED	3LED	3LEDT	ZDC
Total Lumens**	34	84	21-102	61
Input Voltage	10 to 15V	10 to 15V	10 to 15V	11 to 15V
Input Power (W)	2.0	4.2	4.2	6.0
VA	2.4	4.5	4.5	7.2
Efficacy (Lumens/Watt)	18	21	29	19
Color Rendering Index (CRI)	82	82	--	82
Max Candela[†]	31	79	195	51
Dimming	PWM, Phase**	PWM, Phase**	PWM, Phase**	--
RGBW Available	No	No	No	Yes
Luxor Compatibility				
Default	Zoning	Zoning	--	--
ZD Option	Zoning/Dimming	Zoning/Dimming	Zoning/Dimming	--
ZDC Option	--	--	--	Zoning/Dimming/ Color
Minimum Rated Life (L70)	50,000 Hrs	50,000 Hrs	50,000 Hrs	50,000 Hrs
BUG Rating (RD & SQ)	B0-U1-G0	B0-U1-G1	B0-U1-G1	B0-U1-G0



LED RECESSED LUMINAIRES

Glare-free wall light can also function as an up light in 1 or 3 LED. Available in four brass faceplate options. An RGBW version is also available for use with ZDCLink™ systems.

Quick Facts

- Die-cast brass
- Natural, powder coated, or antiqued brass
- Cree® integrated LEDs
- Color temperature filters
- Compatible with Luxor® technology
- Phase and PWM dimmable
- Input voltage: 10-15V

**For optimal performance, use a trailing-edge, phase-cut dimmer.

† Measured using the 3,900K CCT lens. Multipliers for other CCTs include 0.80 (2,700K), 0.65 (4,500K), and 0.65 (5,200K).

‡ Measured using the Round (RD) faceplate. Multipliers for other faceplates include: 1.0 (Square), 2.0 (Spot), and 0.4 (Wall Wash).

Holm

Holm. Born from an industry demand for a comprehensive offering of distinctive line- and low-voltage luminaires for the commercial market. Our products are designed to meet required specifications while echoing the aesthetics of the project. Holm is a Hunter Industries company with more than three decades of engineering expertise, now bringing its Luxor technology to the commercial architectural and landscape lighting market.

Materials

Die-cast C360 brass faceplate, A380 aluminum housing, ABS construction conduit sleeve.

Socket

Socket contains MoistureBlock™ technology, preventing moisture from wicking up into sealed areas of the luminaire.

Wiring

18 AWG (1 mm); SPT-1W; 220°F (105°C); 300V; 10' (3 m) length.

Lamp

Integrated module with Cree LEDs. Gold-plated connectors and conformal coated for maximum reliability and corrosion resistance. Proprietary on-board intelligent driver uses firmware-controlled temperature regulation, maximizing LED life. Field upgradeable and replaceable, the LEDs are rated to 50,000 hrs. Maximum drive current: 1 A.

Optics

Polycarbonate color temperature adjustment lenses included with luminaire: 2,700K (preinstalled), 3,900K (no lens), 4,500K, and 5,200K. Color temperature lenses field serviceable. Beam angle is calculated using LM-79 method for SSL luminaires.

Faceplate

Die-cast brass faceplate.

Power

Input 10-15VAC/VDC 50/60Hz. Remote transformer required (specify separately).

Housing

Die-cast aluminum housing with capacity for 1LED, 3LED, or ZDC integrated LEDs.

IES Classification

Type IV (RD & SQ), Type V (ST), Type II (WW).

Lens

Tempered glass lens with shock resistance and high tolerance for thermal expansion and stress.

Finish

Options of natural brass finish, antiqued finish with brushed (Antique Bronze) or tumbled (Antique Tumbled) effect, or TGIC powder coat finish. Antique finishes sealed with a clear TGIC powder coat layer.

Weight

3.6 lbs. (1.6 kg)

Hardware

Includes 12" (25 mm) ABS conduit sleeve with ½"-14 (13 mm) NPT female hole for strain relief. Strain relief specified separately.

Ambient Operating Temperature

0°F to 140°F (-18°C to 60°C)

Control

ZD or ZDC utilizes Luxor technology to zone luminaires in up to 250 groups, dim each group in 1% increments between 0 and 100%, or change to one of 30,000 colors with RGBW LEDs. Select the ZD option for zoning/dimming or ZDC for zoning/dimming/color. Standard luminaire is zoneable with ZDCLink.

Wildlife-Friendly Lighting

When used with the 3LEDT Output option, this luminaire is Wildlife Lighting Certified by the Florida Fish and Wildlife Conservation Commission.

Sustainability

Innovation meets conservation in the design and manufacturing of our products.

Where we can, we use recycled materials while maintaining superior functionality. Our LED products provide high-quality light at optimal energy efficiency, lifespan, and durability.

Installation Requirements

RD & SQ – Designed for recessed installation in a vertical wall in the down lighting position only.

WW – Designed for recessed installation in a vertical wall in any orientation.

ST – Designed for recessed installation in a vertical or horizontal wall; ensure substantial drainage flow for up lighting (e.g., decking).

Manufacturing









ISO 9001:2015 certified facility

Warranty

5-year limited warranty.

Listings



Luminaire	Luxor Option	Output	Faceplate	Finish	
rECH-8	■ [default] Zone	■ 1LED 60 Lumens	■ RD Round	■ BS Natural Brass	
	■ ZD Zone/Dim	■ 3LED 165 Lumens	■ SQ Square	■ BZ Bronze Metallic	
		■ 3LEDT** Wildlife-Friendly Amber (585-595 nm)	■ ST Spot	■ SV Silver	
	■ ZDC Zone/Dim/Color	■ [default] 90 Lumens	■ WW Wall Wash	■ FB Black	
				■ FW Flat White	
				■ RL RAL Color	
				■ AB Antique Bronze	
				■ AT Antique Tumbled	

EXAMPLE LUMINAIRE CONFIGURATION: **rEch-8-ZDC-RD-SV**



** Available with ZD Luxor option and CU, AB, or AT finishes only

Feet (Meters)	Center Beam		Beam Width	
	Foot-Candle (Lux)	Vertical 45°	Horizontal 70°	
0.5' (0.2 m)	24 fc (262 lx)	0.4' (0.1 m)	0.7' (0.2 m)	
1.0' (0.3 m)	61 fc (655 lx)	0.8' (0.2 m)	1' (0.4 m)	
1.5' (0.5 m)	2.7 fc (29 lx)	1.2' (0.4 m)	2' (0.6 m)	
2.0' (0.6 m)	1.5 fc (16 lx)	1.6' (0.5 m)	3' (0.9 m)	
2.5' (0.8 m)	0.97 fc (10 lx)	2' (0.6 m)	3' (0.9 m)	

Feet (Meters)	Center Beam		Beam Width
	Foot-Candle (Lux)	Vertical 90°	
0.5' (0.2 m)	268 fc (2,885 lx)	1' (0.4 m)	
1.0' (0.3 m)	67 fc (721 lx)	2' (0.6 m)	
1.5' (0.5 m)	30 fc (321 lx)	3' (0.9 m)	
2.0' (0.6 m)	17 fc (181 lx)	4' (1.2 m)	
2.5' (0.8 m)	11 fc (115 lx)	5' (1.5 m)	

Feet (Meters)	Center Beam		Beam Width	
	Foot-Candle (Lux)	Vertical 40°	Horizontal 70°	
0.5' (0.2 m)	83 fc (895 lx)	0.4' (0.1 m)	0.7' (0.2 m)	
1.0' (0.3 m)	21 fc (224 lx)	0.8' (0.2 m)	1' (0.4 m)	
1.5' (0.5 m)	9 fc (99 lx)	1' (0.4 m)	2' (0.6 m)	
2.0' (0.6 m)	5 fc (56 lx)	2' (0.6 m)	3' (0.9 m)	
2.5' (0.8 m)	3 fc (36 lx)	2' (0.6 m)	4' (1 m)	



rEcho-8 1LED Illuminance at a Distance RD/SQ

Feet (Meters)	Center Beam	Beam Width	
	Foot-Candle (Lux)	Vertical 45°	Horizontal 75°
0.5' (0.2 m)	16 fc (174 lx)	0.4' (0.1 m)	0.7' (0.2 m)
1.0' (0.3 m)	4 fc (43 lx)	0.8' (0.2 m)	1.5' (0.5 m)
1.5' (0.5 m)	1.8 fc (19 lx)	1.2' (0.4 m)	2.2' (0.7 m)
2.0' (0.6 m)	1.0 fc (11 lx)	1.6' (0.5 m)	3' (0.9 m)
2.5' (0.8 m)	0.6 fc (7 lx)	2' (0.6 m)	4' (1 m)

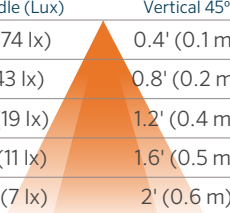

rEcho-8 1LED Illuminance at a Distance ST

Feet (Meters)	Center Beam	Beam Width
	Foot-Candle (Lux)	Vertical 90°
0.5' (0.2 m)	136 fc (1,467 lx)	1' (0.3 m)
1.0' (0.3 m)	34 fc (366 lx)	2' (0.6 m)
1.5' (0.5 m)	15 fc (162 lx)	3' (0.9 m)
2.0' (0.6 m)	9 fc (97 lx)	4' (1.2 m)
2.5' (0.8 m)	4 fc (43 lx)	5' (1.5 m)

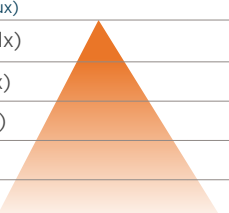

rEcho-8 1LED Illuminance at a Distance WW

Feet (Meters)	Center Beam	Beam Width	
	Foot-Candle (Lux)	Vertical 50°	Horizontal 60°
0.5' (0.2 m)	33 fc (355 lx)	0.5' (0.2 m)	0.7' (0.2 m)
1.0' (0.3 m)	8 fc (86 lx)	1' (0.3 m)	1.3' (0.4 m)
1.5' (0.5 m)	4 fc (43 lx)	1.5' (0.5 m)	2.0' (0.6 m)
2.0' (0.6 m)	2 fc (22 lx)	2.0' (0.6 m)	2.6' (0.8 m)
2.5' (0.8 m)	1.3 fc (14 lx)	2.4' (0.7 m)	3.3' (1 m)

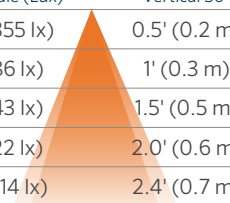

rEcho-8 3LED Illuminance at a Distance RD/SQ

Feet (Meters)	Center Beam	Beam Width	
	Foot-Candle (Lux)	Vertical 40°	Horizontal 60°
0.5' (0.2 m)	33 fc (355 lx)	0.4' (0.1 m)	0.6' (0.2 m)
1.0' (0.3 m)	8 fc (86 lx)	0.8' (0.2 m)	1' (0.4 m)
1.5' (0.5 m)	4 fc (43 lx)	1' (0.4 m)	2' (0.6 m)
2.0' (0.6 m)	2 fc (22 lx)	2' (0.5 m)	3' (0.8 m)
2.5' (0.8 m)	1.3fc (14 lx)	2' (0.6 m)	3' (0.8 m)

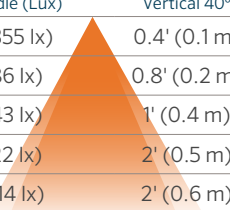

rEcho-8 3LED Illuminance at a Distance ST

Feet (Meters)	Center Beam	Beam Width
	Foot-Candle (Lux)	Vertical 85°
0.5' (0.2 m)	355 fc (3,821 lx)	1' (0.4 m)
1.0' (0.3 m)	89 fc (958 lx)	2' (0.5 m)
1.5' (0.5 m)	39 fc (424 lx)	3' (0.9 m)
2.0' (0.6 m)	22 fc (239 lx)	4' (1.2 m)
2.5' (0.8 m)	14 fc (153 lx)	5' (1.5 m)

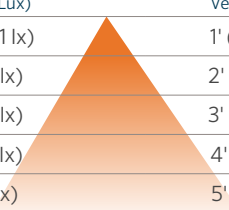

rEcho-8 3LED Illuminance at a Distance WW

Feet (Meters)	Center Beam	Beam Width	
	Foot-Candle (Lux)	Vertical 50°	Horizontal 70°
0.5' (0.2 m)	88 fc (946 lx)	0.5' (0.2 m)	0.7' (0.2 m)
1.0' (0.3 m)	22 fc (237 lx)	1' (0.3 m)	1.3' (0.4 m)
1.5' (0.5 m)	10 fc (106)	1.5' (0.5 m)	2.0' (0.6 m)
2.0' (0.6 m)	6 fc (59 lx)	2' (0.6 m)	2.5' (0.8 m)
2.5' (0.8 m)	4 fc (38 lx)	3' (0.9 m)	3' (0.8 m)

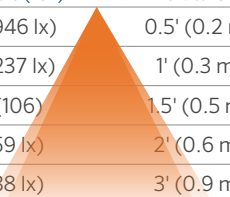

SPECIFICATION SHEET

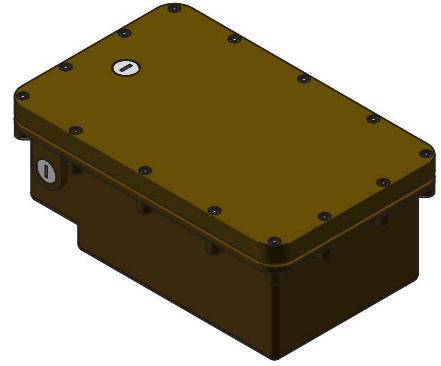

DIRECT-BURIAL

FEATURES

- 10 YEAR FREE REPLACEMENT WARRANTY
- FULLY DIMMABLE, WITH LOW-VOLTAGE MAGNETIC DIMMER
- COMPRESSION MOLDED, FIBERGLASS REINFORCED POLYESTER COMPOSITE HOUSING
- STANDARD WITH MANDATORY SECONDARY PROTECTION
- RESISTANT TO RUST, CORROSION, OILS, GASOLINE, & DETERGENTS
- PRIMARY WIRING COMPARTMENT & ANTI-SIPHON BARRIER
- BUILT IN THE USA TO THE HIGHEST STANDARDS
- MEETS OR EXCEEDS ALL UL, CUL, ANSI/UL, CSA REQUIREMENTS.

REQUIREMENTS



- LISTED TO UL STANDARD 1838 FOR LANDSCAPE LIGHTING
- MANDATORY SECONDARY PROTECTION, AS STATED IN THE NATIONAL ELECTRIC CODE ARTICLE 411, (1993, 1996, 1999, 2002, 2005 AND 2008)
- MAY BE USED WITH INDIVIDUAL "LISTED" COMPONENTS TO MEET "SYSTEM" REQUIREMENTS, AS LONG AS ALL PARTS LISTED TO SAME ANSI/UL STANDARD

PART NUMBER
PRIMARY VOLTAGE
OUTPUT VOLTAGE
BREAKERS
FREQUENCY
DIMENSIONS
WEIGHT

CLASS 1	CLASS 1
1030-TL (100 Watt)	1031-TL (300 Watt)
120VAC-1A MAX	120VAC-3A MAX
12-15VAC-8.3A MAX	12-15VAC-25A
1x10A	1x25A
60 Hz	60 Hz
12" x 7.5" x 6"	12" x 7.5" x 6"
20 LBS.	22 LBS.

