



Fixture Type
Materials
Finish

Garden Fixture
Metal
Ageed Brass

Lamp Type
Lamp Quantity
Lamp Included
Wattage
Input Voltage
Delivered Lumens
Kelvin Temperature
CRI
Power S Type
Power S Quantity
Power S Location
Dimming Type

E27 LED
1
No
15 W MAX
n/a
n/a
n/a
n/a
n/a
n/a
n/a
n/a

Designer:

Aldo Bernardi

Listings

CE
WET
This product is not UL certified. We offer UL certification for an additional cost and lead time.

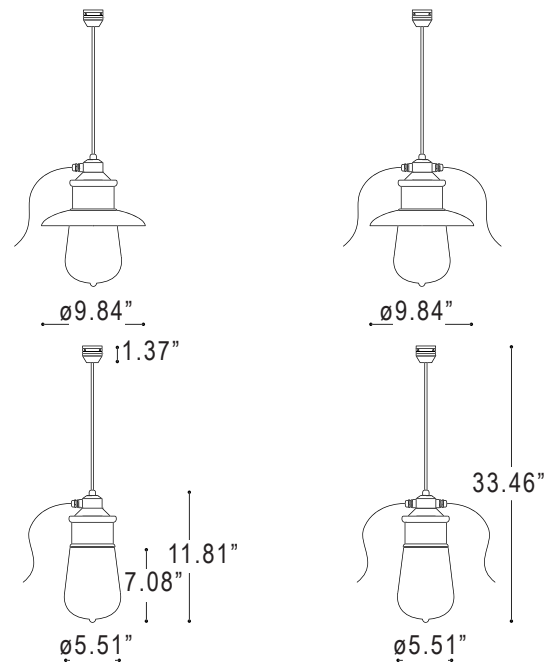



538 Alvin Bernard

lula, LLC
2361-B S. Robertson Blvd.
Los Angeles, CA. 90032
424.333.0054
info@lula.biz





Serie di sospensioni su cavo di acciaio AISI 316. Le sospensioni, provviste di asta di sostegno centrale ed aggancio aereo, possono avere una o due uscite del cavo elettrico; ogni uscita è provvista del cavo con lunghezza standard 2 mt. L'altezza dell'asta o la lunghezza del cavo possono essere modificate al momento dell'installazione.

Per finalizzare in modo corretto e sicuro l'installazione, Aldo Bernardi propone **cavo acciaio AISI 316, pressato su terminali laterali** sempre in acciaio AISI 316 (tecnica consolidata nel campo della nautica). **FONDAMENTALE È RICEVERE, DA PARTE VOSTRA, LA MISURA PRECISA AL MILLIMETRO DELLA DISTANZA DA COPRIRE.** Sarà nostra cura realizzare il cavo di ancoraggio su misura. Accessori da ordinare a parte.

Series of suspension on steel cable. The suspensions, provided with a central support rod and aerial hooking, can have one or two outputs of the electric cable, with a standard length of 2 meters. each. The height of the rod or the length of the cable, can be changed at the time of installation.

To finalize the installation correctly and safely, Aldo Bernardi proposes **AISI 316 steel cable, pressed on lateral terminals**, also in AISI 316 stainless steel (well-established technique in the nautical field). **THE KEY ISSUE IS TO RECEIVE, ON YOUR PART, THE PRECISE MEASUREMENT MILLIMETER OF DISTANCE TO COVER.** It will be our responsibility to make the custom-made anchor cable. Accessories to be ordered separately.

ARTICOLO ITEM	DESCRIZIONE DESCRIPTION	ATTACCO SOCKET	POTENZA POWER	PESO GR. WEIGHT GR.	VOL. IN M³ VOL. IN M³	FASCIA PREZZO PRICE RANGE
G.OUT1/TESA	Sospensione per tesata, in ottone anticato, ad una uscita cavo nero 2 metri, con vetro trasparente Head-light pendant, in aged brass, single 2-meters black cable output, clear glass	E27	15W LED	4500	0,1	B68
G.OUT1/P/TESA	Sospensione per tesata con riflettore in ottone anticato, ad una uscita cavo nero 2 metri, con vetro trasparente Head-light pendant with shade, in aged brass, single 2-meters black cable output, clear glass	E27	15W LED	4900	0,1	B78
G.OUT2/TESA	Sospensione per tesata, in ottone anticato, a due uscite cavo nero di 2 metri ciascuna, con vetro trasparente Head-light pendant, in aged brass, two black cable exits of 2 meters each one, clear glass	E27	15W LED	4500	0,1	B72
G.OUT2/P/TESA	Sospensione per tesata con riflettore in ottone anticato, a due uscite cavo nero di 2 metri ciascuna, con vetro trasparente Head-light pendant with shade, in aged brass, two black cable exits of 2 meters each one, clear glass	E27	15W LED	4900	0,1	B81

CE ⊕ IP65





Art. G.OUT1/TESA



Art. G.OUT2/TESA



Art. G.OUT1/P/TESA



Art. G.OUT2/P/TESA





Esempio di tesata con distanza totale 5000 mm:
Head light structure with total length of 5000 mm:

- 1) Art. **STILL/MT/4,673**
- 1) Art. **STILL/TERMINALS**
- 2) Art. **BOLT**
- 1) Art. **OUT/ROS/O**
- 3) Art. **OUT/DER/O**
- 1) Art. **G.OUT1/P/TESA**
- 1) Art. **G.OUT2/P/TESA**
- 2) Art. **G.OUT2/TESA**



ESEGUITI TEST SECONDO NORME UNI EN 12385-1:2009 PER CARICO
 LIMITE CONSIGLIATO PARI A **3,8 KN**
 PERFORMED TEST ACCORDING TO UNI EN 12385-1: 2009 FOR
 RECOMMENDED LIMIT LOAD OF **3,8 KN**



Art. STILL/MT + Art. STILL/TERMINALS



Art. BOLT



Art. OUT/ROS/O



Art. OUT/DER/O



Art. OUT/SUP/O



Art. RING2



Art. RING3



Art. RING4

Per finalizzare in modo corretto e sicuro l'installazione, Aldo Bernardi propone **cavo acciaio AISI 316, pressato su terminali laterali** sempre in acciaio AISI 316 (tecnica consolidata nel campo della nautica).

To finalize the installation correctly and safely, Aldo Bernardi proposes **AISI 316 steel cable, pressed on lateral terminals**, also in AISI 316 stainless steel (well-established technique in the nautical field).



Art. STILL/MT



Art. STILL/TERMINALS



Art. BOLT



Art. OUT/SUP/O

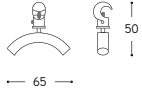

Art. OUT/DER/O

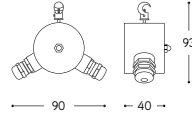

Art. OUT/ROS/O

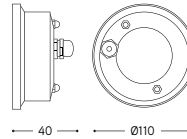

Art. RING2

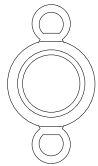

Art. RING3

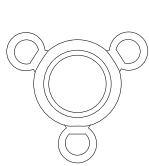

Art. RING4

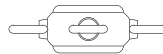
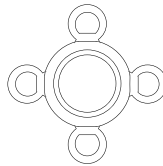

ARTICOLO ITEM	DESCRIZIONE DESCRIPTION	PESO GR. WEIGHT GR.	VOL. IN M ³ VOL. IN M ³	FASCIA PREZZO PRICE RANGE
STILL/MT/1	Cavo acciaio AISI 316 Ø 4 mm., lunghezza e fascia prezzo standard 1 mt. Stainless steel AISI 316 Ø 4 mm., cable price range and standard length of one meter	70		B1
STILL/TERMINALS	Set di 2 terminali per cavo acciaio inox AISI 316/ set of two stainless still AISI 316 terminals (Terminal Welded Form M 8/4 MM - Terminal fork 4 MM)	190	0,02	B38
OUT/DER/O	Scatola di derivazione in ottone anticato per tesata Head light connection box in aged brass	380		B37
OUT/SUP/O	Passacavo per tesata in ottone anticato Fairlead for head light in aged brass	30		B10
OUT/ROS/O	Scatola di connessione in ottone anticato per tesata, da fissare alla parete / Head light connection box, to be fixed to the wall	580	0,002	B37
PAL/H5	Palo in ottone anticato h. 5 mt 5-meters-height aged brass pole	48.000	0,3	B151
PAL/H5/EC1	Palo in ottone anticato h. 5 mt., con 1 uscita cavo elettrico 5-meters-heightaged brass pole with 1 electric cable exit	48.000	0,3	B151
PAL/H5/EC2	Palo in ottone anticato h. 5 mt., con 2 uscite cavo elettrico 5-meters-heightaged brass pole with 2 electric cable exits	48.000	0,3	B151
PALH5/EC3	Palo in ottone anticato h.5 mt., con 3 uscite cavo elettrico 5-meters-heightaged brass pole with 3 electric cable exits	48.000	0,3	B151
PALH5/EC4	Palo in ottone anticato h.5 mt., con 4 uscite cavo elettrico 5-meters-heightaged brass pole with 4 electric cable exits	48.000	0,3	B151
RING2	Anello per palo in ottone anticato comprensivo di 2 golfari laterali Pole ring in aged brass, with 2 lateral lifting eye bolts	1035		B37
RING3	Anello per palo in ottone anticato comprensivo di 3 golfari Pole ring in aged brass, with 3 lifting eye bolts	1115		B39
RING4	Anello per palo in ottone anticato comprensivo di 4 golfari Pole ring in aged brass, with 4 lifting eye bolts	1230		B42
BOLT	Golfare ad occhio circolare per ancoraggio della tesata Lifting eye bolt for secure head light structure	73		B5
INT.G	Interrato per PAL/H5 Buried base for PAL/H5	8700	0,15	B59



Esempio di composizione da palo a parete con entrata cavo da parete
 Example of composition from pole to wall with cable entry from the wall

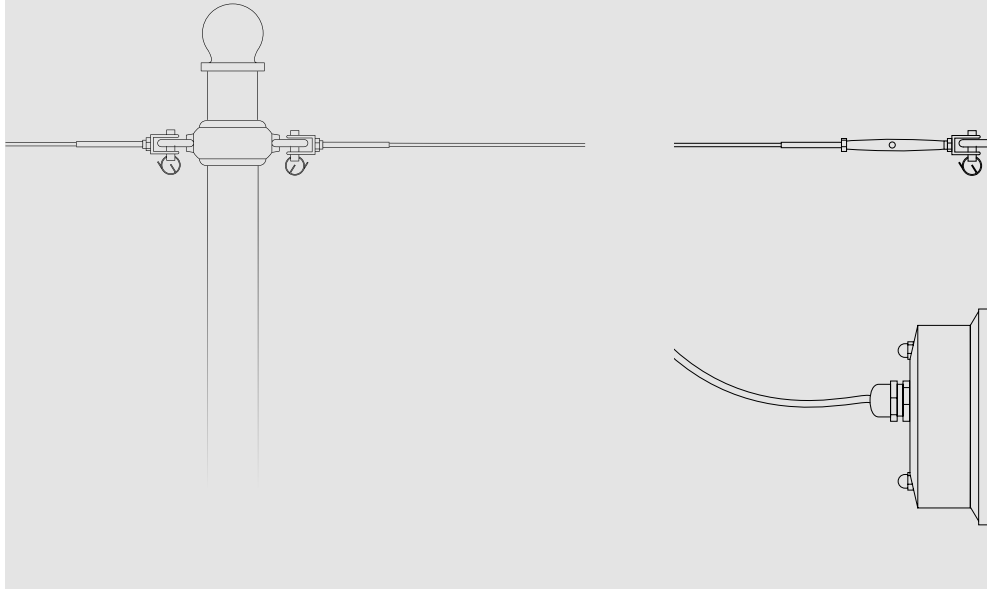

Per finalizzare in modo corretto e sicuro l'installazione, Aldo Bernardi propone **cavo acciaio AISI 316, pressato su terminali laterali** sempre in acciaio AISI 316 (tecnica consolidata anche nel campo della nautica).

To finalize the installation correctly and safely, Aldo Bernardi proposes **AISI 316 steel cable, pressed on lateral terminals**, also in AISI 316 stainless steel (well-established technique also in the nautical field).

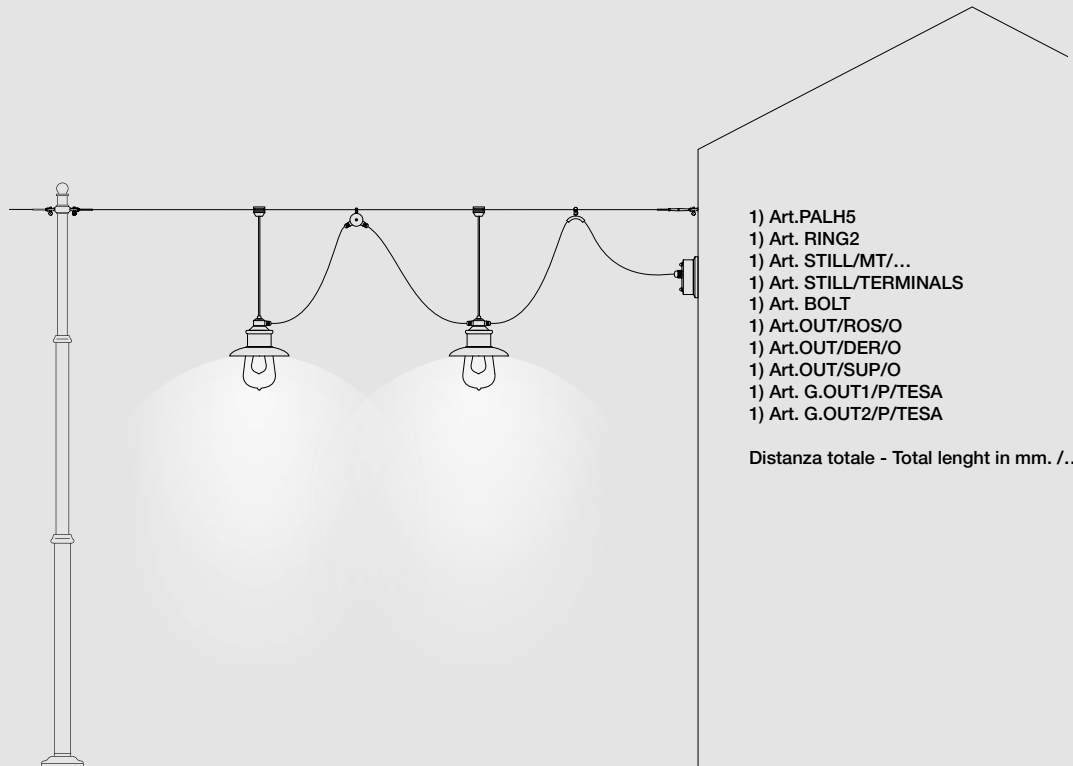

- 1) Art. PALH5
- 1) Art. RING2
- 1) Art. STILL/MT/...
- 1) Art. STILL/TERMINALS
- 1) Art. BOLT
- 1) Art. OUT/ROS/O
- 1) Art. OUT/DER/O
- 1) Art. OUT/SUP/O
- 1) Art. G.OUT1/P/TESA
- 1) Art. G.OUT2/P/TESA

Distanza totale - Total length in mm. /...



Esempio di composizione tra vari pali
Example of composition between pales

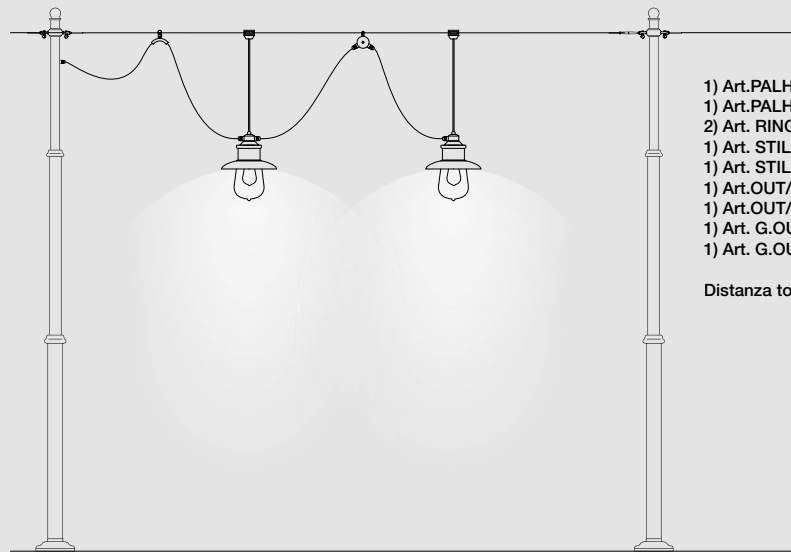

- 1) Art. PALH5/EC1
- 1) Art. PALH5
- 2) Art. RING2
- 1) Art. STILL/MT/...
- 1) Art. STILL/TERMINALS
- 1) Art. OUT/DER/O
- 1) Art. OUT/SUP/O
- 1) Art. G.OUT1/P/TESA
- 1) Art. G.OUT2/P/TESA

Distanza totale - Total lenght in mm. /...

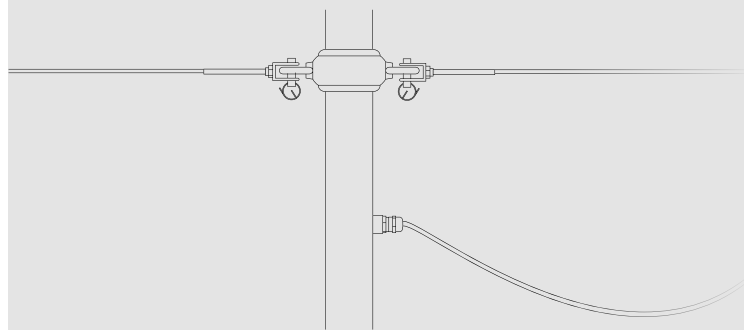

Esempio di composizione tra pali e parete con entrata cavo nel primo palo
Example of composition between pales and wall with cable entry from first pole

FONDAMENTALE È RICEVERE, DA PARTE VOSTRA, LA MISURA PRECISA AL MILLIMETRO DELLA DISTANZA CHE INTENDETE COPRIRE. Sarà nostra cura realizzare il cavo di ancoraggio su misura. Tutti gli accessori sono da ordinare a parte.

THE KEY ISSUE IS TO RECEIVE, ON YOUR PART, THE PRECISE MEASUREMENT MILLIMETER OF DISTANCE TO COVER. It will be our responsibility to make the custom-made anchor cable. Accessories to be ordered separately.

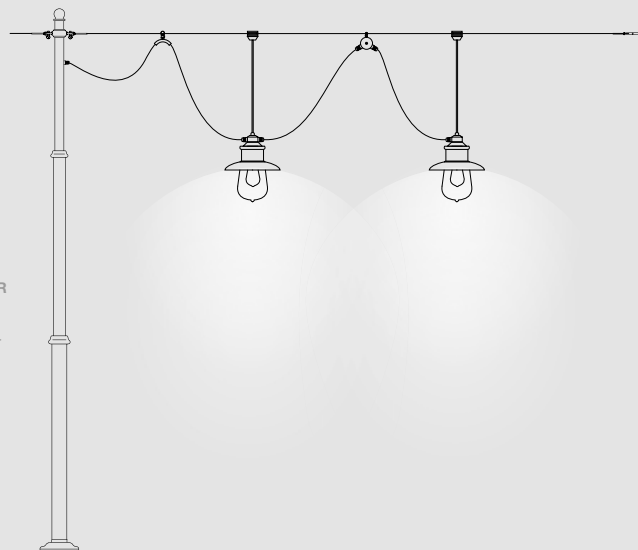

- 1) Art. PALH5/EC1
- 1) Art. RING2
- 1) Art. STILL/MT/...
- 1) Art. STILL/TERMINALS
- 1) Art. BOLT
- 1) Art. OUT/SUP/O
- 1) Art. OUT/DER/O
- 1) Art. G.OUT1/P/TESA
- 1) Art. G.OUT2/P/TESA

Distanza totale - Total lenght in mm. /...



Art. PAL/H5

LINEA
Guinguette outdoor

PAL/H5/EC1

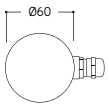

PAL/H5/EC2

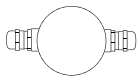

PAL/H5/EC3

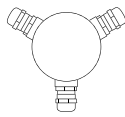

PAL/H5/EC4

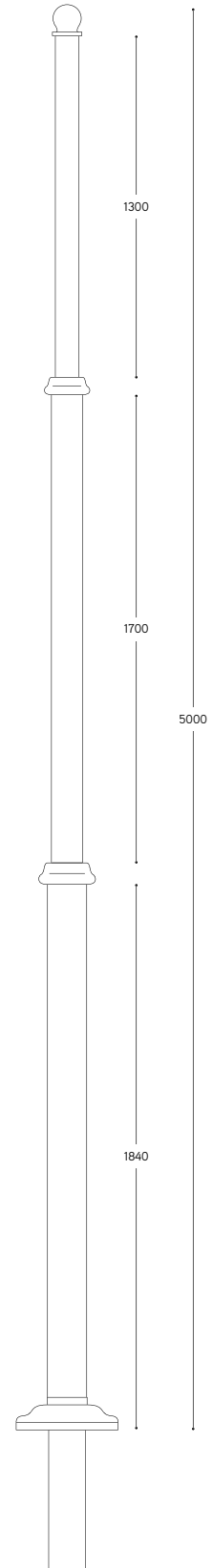
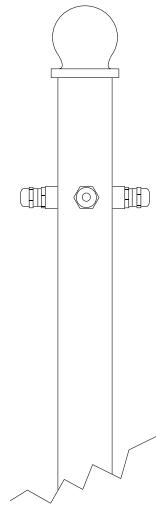
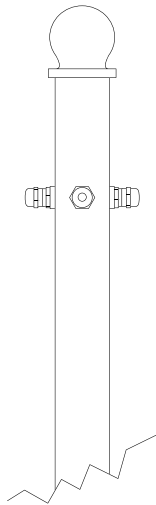
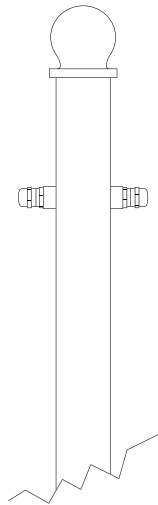
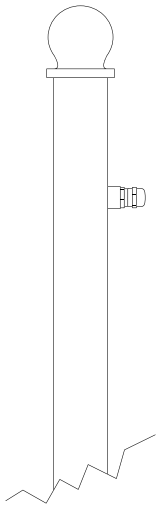
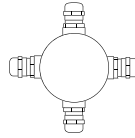

Art. INT.G

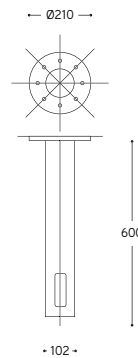

Insieme composto da:
Set made of:

- 3) Art. STILL/MT/...
- 3) Art. STILL/TERMINALS
- 1) Art. RING3
- 1) Art.PALH5/EC3
- 1) Art.OUT/SUP/O

Distanza totale
Total lenght in mm. /...

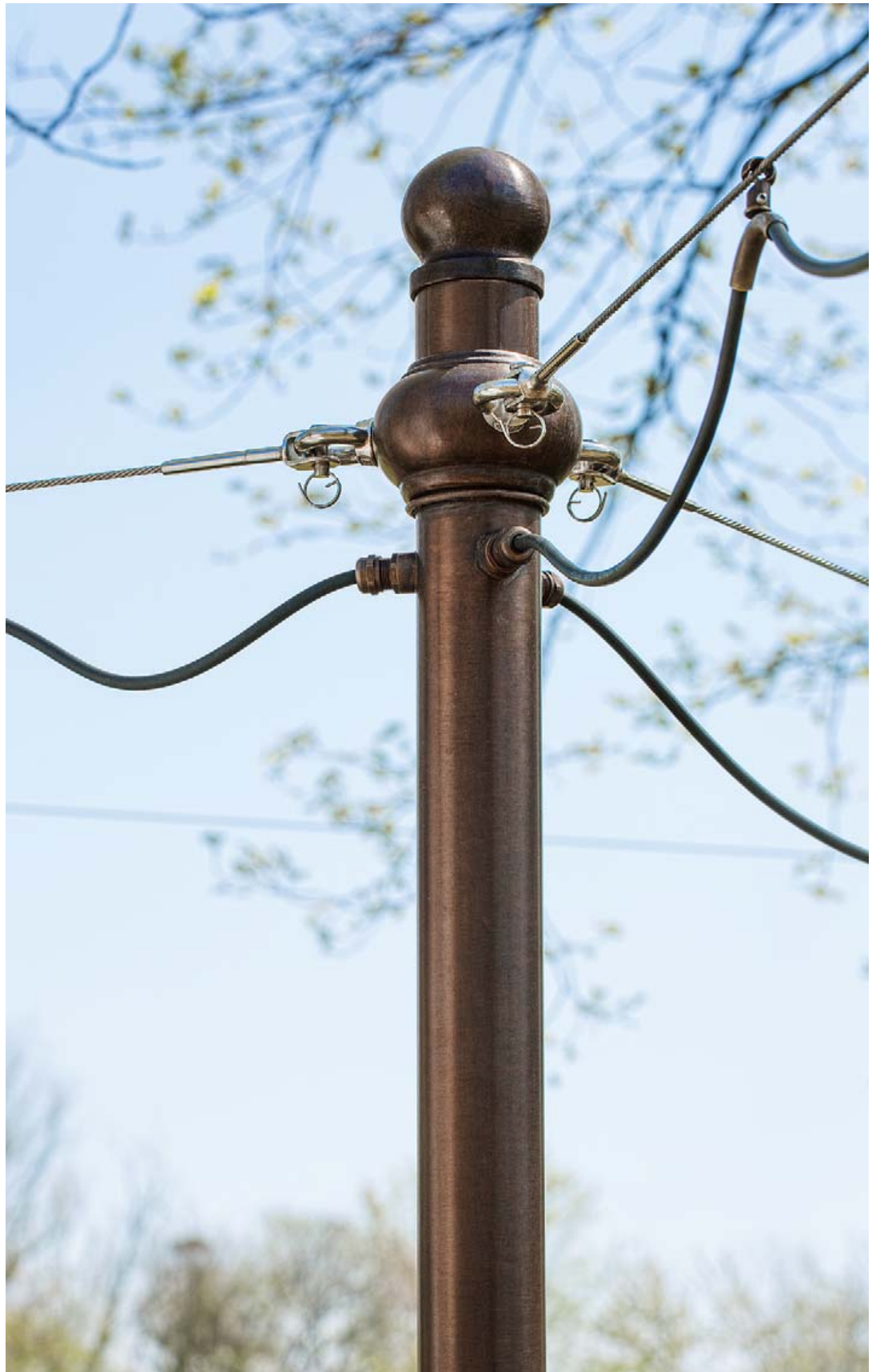

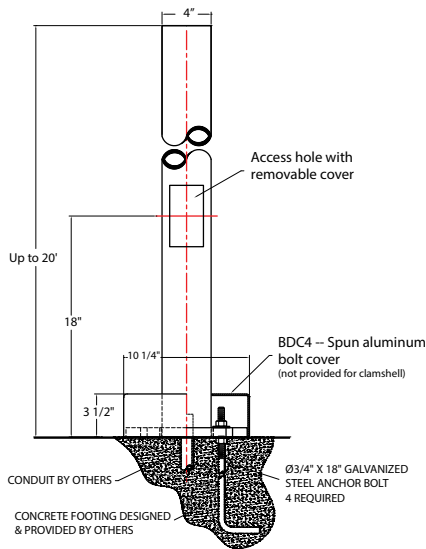

Mounting slot for Ø3/4" anchor bolt. 4 required

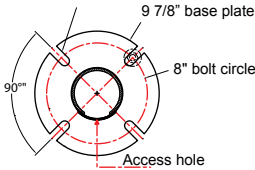

MOUNTING DETAIL

Various heights and fixture configurations may require a different bolt circle. Consult factory for specific bolt circle required.

Material

Aluminum pole bases and base plates shall be cast from 356 aluminum alloy. Shafts shall be extruded 6061-T6 aluminum. Available in 3", 4" or 5" diameter. Wall thickness 0.125" or 0.188" or 0.250.

Mounting

Four anchor bolts provided are 3/4"x1.8". Anchor bolts, nuts and washers are hot dipped galvanized steel. Spun aluminum bolt cover provided.

Access

All poles are provided with a hand access opening and cover. Hand hole cover is secured by two stainless steel machine screws. (Tamper-proof screws provided upon request).

Grounding

All poles are provided with an aluminum grounding lug integrated to inner wall of shaft, 180 degrees to hand hole. Grounding lug is drilled and tapped to accommodate 1/4"-20 stainless steel machine screw.

Pole Height

Maximum pole height is 20-feet.

Accessories

Banner arms, ladder rests, signage, flag pole holder and GFI receptacles are optional.

Catalog Logic

BD3S10.125 - **BAA** - **CCS1902** - **41**
Pole Accessory Clamshell Finish

Catalog Number

















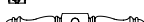
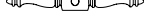
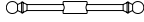

See page 2 for more ordering info

1	Item Number	OD	Height	Wall	80 MPH	100 MPH
	BD3S3	3	3	0.125	10.10	6.20
	BD3S4	3	4	0.125	9.20	5.30
	BD3S5	3	5	0.125	8.00	4.70
	BD3S6	3	6	0.125	6.90	4.00
	BD3S7	3	7	0.125	6.00	3.60
	BD3S8	3	8	0.125	5.20	3.00
	BD3S9	3	9	0.125	4.50	2.60
	BD3S10	3	10	0.125	3.90	2.00
	BD3S11	3	11	0.125	3.40	1.70
	BD3S12	3	12	0.125	2.90	1.30
	BD4S3	4	3	0.125	27.60	17.50
	BD4S4	4	4	0.125	22.10	14.00
	BD4S5	4	5	0.125	19.90	12.60
	BD4S6	4	6	0.125	17.70	11.25
	BD4S7	4	7	0.125	16.00	10.10
	BD4S8	4	8	0.125	14.20	9.00
	BD4S9	4	9	0.125	12.00	7.60
	BD4S10	4	10	0.125	10.10	6.20
	BD4S11	4	11	0.125	8.80	5.30
	BD4S12	4	12	0.125	7.50	4.40
	BD4S13	4	13	0.125	6.00	3.50
	BD4S14	4	14	0.125	5.50	2.70
	BD4S5	4	5	0.188	33.10	21.00
	BD4S6	4	6	0.188	29.50	18.70
	BD4S7	4	7	0.188	27.60	16.80
	BD4S8	4	8	0.188	23.60	15.00
	BD4S9	4	9	0.188	20.00	12.60
	BD4S10	4	10	0.188	16.80	10.30
	BD4S11	4	11	0.188	14.60	8.80
	BD4S12	4	12	0.188	12.50	7.30
	BD4S13	4	13	0.188	10.00	5.80
	BD4S14	4	14	0.188	9.10	4.50
	BD4S15	4	15	0.188	8.10	3.60
	BD4S16	4	16	0.188	7.20	2.80
	BD5S6	5	6	0.125	30.00	19.30
	BD5S7	5	7	0.125	27.10	17.40
	BD5S8	5	8	0.125	24.00	15.50
	BD5S9	5	9	0.125	21.60	13.90
	BD5S10	5	10	0.125	19.20	12.40
	BD5S11	5	11	0.125	17.10	10.80
	BD5S12	5	12	0.125	15.00	9.30
	BD5S13	5	13	0.125	12.80	8.10
	BD5S14	5	14	0.125	11.50	7.00
	BD5S15	5	15	0.125	10.10	6.00
	BD5S16	5	16	0.125	8.80	5.10
	BD5S17	5	17	0.125	7.70	4.30
	BD5S18	5	18	0.125	6.80	3.60
	BD5S19	5	19	0.125	5.70	2.80
	BD5S20	5	20	0.125	4.70	2.20
	BD5S7	5	7	0.188	32.80	25.70
	BD5S8	5	8	0.188	29.30	22.80
	BD5S9	5	9	0.188	26.40	20.50
	BD5S10	5	10	0.188	23.50	18.20
	BD5S11	5	11	0.188	21.00	16.40
	BD5S12	5	12	0.188	18.60	14.60
	BD5S13	5	13	0.188	16.70	13.00
	BD5S14	5	14	0.188	14.80	11.40
	BD5S15	5	15	0.188	13.30	10.40



























BD5S16	5	16	0.188	11.80	9.00
BD5S17	5	17	0.188	10.50	7.90
BD5S18	5	18	0.188	9.20	6.80
BD5S19	5	19	0.188	8.20	5.90
BD5S20	5	20	0.188	7.20	5.00

2 ACCESSORIES

GF115	(15 amp GFCI receptacle outlet)	
GF120	(20 amp GFCI receptacle outlet)	
GFI-WPU	(20 amp GFCI receptacle with weather proof in-use cover)	
BAA	(Cast Banner Arm A for 24" wide banner)	
BAB	(Cast Banner Arm B for 30" wide banner)	
BAC	(Cast Banner Arm C for 30" wide banner)	
LR1	(Cast Ladder Rest 1)	
LR3	(Cast Ladder Rest 3)	
LR4	(Cast Ladder Rest 4)	
LR5	(Cast Ladder Rest 5)	
SIGN A	(Cast Sign A; 30" x 9", 8 letters/numbers on one line; requires Banner Arm to hang)	
SIGN B	(Cast Sign B; 31" x 7", 12 letters/numbers on one line; requires Banner Arm to hang)	
SIGN C	(Cast Sign C; 27" x 11", two rows of 8 letters/numbers on each line, requires Banner Arm to hang)	
SIGN D	(Cast Sign D; 11" x 6 1/2", 4 letters/numbers on one line)	
SIGN E	(Cast Sign E; comes with pole clamp, 24 1/2" x 6", 9 letters/numbers on one line)	
FPH1	(Flag Pole Holder)	
TP	(Tamper Proof Screws)	
BDC	(Spun Aluminum Bolt cover)	
SBDC	(Split Bolt Cover)	

3 2-PIECE CLAMSHELLS

CCS0300		CCS1302		CCS2902	
CCS0509		CCS1501		CCS2903	
CCS0701		CCS1502		CCS5301	
CCS0702		CCS1504		CCS5401	
CCS0900		CCS1509		CCS5509	
CCS1100		CCS1607		CCS6303	
CCS1201		CCS1608		CCS6502	
CCS1301		CCS1902		CCS9103	

4 FINISHES

*Premium and Marine Grade Finish have additional charges

Standard Colors	Standard Grade	Marine Grade*	Standard Colors	Standard Grade	Marine Grade*
Aspen Green	10	10M	Architectural Bronze	51	51M
Cantaloupe	11	11M	Patina Verde	52	52M
Lilac	12	12M	Copper Clay	53	53M
Putty	13	13M	Silver	56	56M
Raw Unfinished	40	NA	Black Verde	61	61M
Black	41	41M	Painted Chrome	70	70M
Forest Green	42	42M	Painted Copper	71	71M
Bright Red	43	43M	Textured Black	72	72M
White	44	44M	Matte Black	73	73M
Bright Blue	45	45M	Textured Architectural Bronze	76	76M
Sunny Yellow	46	46M	Textured White	77	77M
Aqua Green	47	47M	Textured Silver	78	78M
Galvanized	49	NA	PREMIUM FINISH	Premium Grade*	Marine Grade*
Navy	50	50M	Carbon Graphite	96	96M
			Wood Grain	99	NA

Consult Factory for additional paint charges and availability.

Finish

A polyester powder coat high quality finish is electro-statically applied and baked at 430° for exceptional durability and color retention. Products undergo an intensive five-step cleansing and pretreatment process for maximum paint adhesion.

Marine grade finish provides superior salt, humidity, and UV protection. This coating withstands up to 3000 hours of continuous salt spray, comes with a 5-year warranty and is available in either a textured or gloss surface.

