



Fixture Type
Materials
Finish

Recessed
Aluminium
White
*consult factory for other finishes

Lamp Type
Lamp Quantity
Lamp Included
Wattage
Input Voltage
Delivered Lumens
Kelvin
CRI
Power S Type
Power S Quantity
Power S Location
Dimming Type

LED
1
Yes
10.4W
120V
908 lm
2700K
90
Driver
1
Integral
ELV

Designer

Delta

Listings

ETL
DRY
JA8 Listed

MINIGRID 86 S SP ST

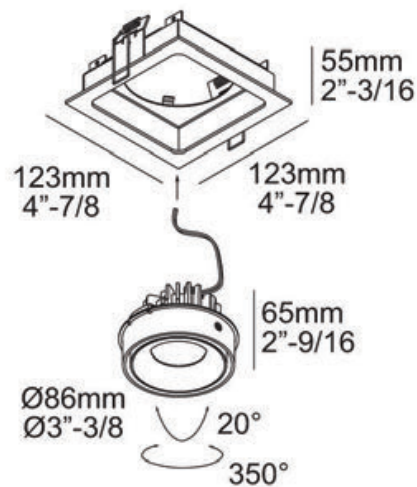



The Snap-In principle equals modularity and flexibility at its best, it grants the opportunity to the lighting designer to use his creativity: combine single and double units, use multiple beam angles or play with colour. Dividing a luminaire into multiple modular parts not only creates uniformity within one family, it also facilitates the installation by giving the opportunity to the installer to place the frame in advance. No need to worry for the lighting modules in further finishing of the room, as the modules can be clicked into the frame afterwards.

Specification	Single (S)				Double (2S)			
	ST		TL		ST		TL	
	SP	MP/HP	SP	MP/HP	SP	MP/HP	SP	MP/HP
LED Aperture (each):	1 1/16"	23/4"	1 1/16"	23/4"	1 1/16"	23/4"	1 1/16"	23/4"
Ceiling Cut-out:	4 3/8" x 4 3/8"		5 1/8" x 5 1/8"		87/16" x 43/8"		9 3/16" x 5 1/8"	
Ceiling Thickness:	Max. 1"							
Adjustability:	0-20° / 350°	0-25° / 355°	0-20° / 350°	0-25° / 355°	0-20° / 350°	0-25° / 355°	0-20° / 350°	0-25° / 355°
Rating:	IP20							

Performance	Static CCT	Soft Dim
LED Maintenance:	L90>50,000h	
McAdam Step:	2	3
CRI:	90	90
*Minigrad 86 S/2S SP:	10.4W / 2 x 10.4W	9.5W / 2 x 9.5W
*Minigrad 86 S/2S MP:	16.3W / 2 x 16.3W	
*Minigrad 86 S/2S HP:	23.2W / 2 x 23.2W	

Delivered Lumens	3000K			2700-1800K
**See page 4 for full details	SS	SP	FL	FL
Minigrad 86 S SP:	936Lm	918Lm	908Lm	521Lm
Minigrad 86 S MP:	1608Lm	1629Lm	1828Lm	
Minigrad 86 S HP:	2234Lm	2263Lm	2593Lm	

Ordering

ALL BOXES MUST BE FILLED IN TO CORRECTLY ORDER

Example: MGR86S-SPFL35A-W-B-TLIATD1-120

Luminaire	Size	Shape	Power*	Optic	CCT	Function	Finish	Inner Finish	Installation	Applications	Controls***	
MGR Minigrad In	86 86mm / 3 3/8" Snap-In Module	S Square	SP Standard Power	SS Super Spot	27 2700K	A Adjustable	B Black	B Black	ST Recessed with small trim in white	IAT ^(2,3) New Construction IC Airtight	D1-120 0-10V dim 120V	
			MP Medium Power	SP Spot	30 3000K		W White	W White	TL Recessed with mud-in trimless kit		NPF New Construction Non-IC Plasterframe	D1-277 0-10V dim 277V
			HP High Power	FL Flood	35 3500K						NAT ⁽⁴⁾ New Construction NON-IC Airtight	D8-120 ⁽²⁾ FE ELV dim 120V
			SP Standard Power	FL Flood	SD ⁽¹⁾ 1800-2700K							



MINIGRID 86 S SP ST

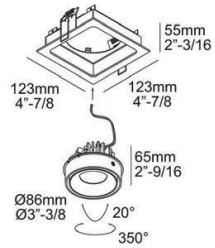

MINIGRID 86 S MP/HP ST

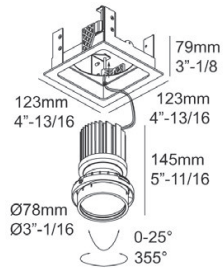

MINIGRID 86 S SP TL

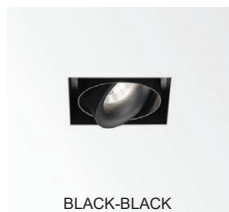
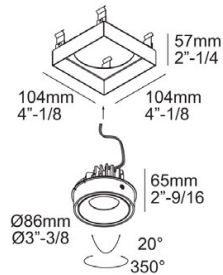

MINIGRID 86 S MP/HP TL

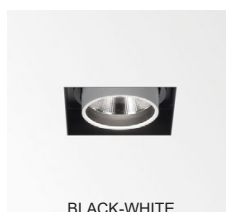
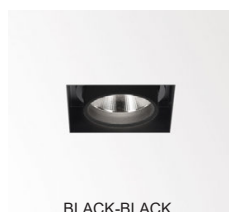
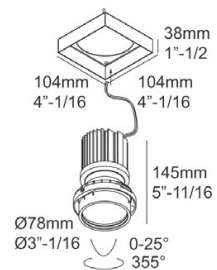

Performance	Static CCT (SP)			Static CCT (MP/HP)			Soft Dim			
*S/2S SP:	10.4W / 2 x 10.4W						9.5W / 2 x 9.5W			
*S/2S MP:				16.3W / 2 x 16.3W						
*S/2S HP:				23.2W / 2 x 23.2W						
**Super Spot (SS):	18°			20°						
**Spot (SP):	33°			37°						
**Flood (FL):	50°			50°			40°			
Delivered Lumens	2700K			3000K			3500K			3000-1800K
Optic:	SS	SP	FL	SS	SP	FL	SS	SP	FL	FL
Minigrig 86 S SP:	898Lm	882Lm	871Lm	936Lm	918Lm	908Lm	965Lm	947Lm	939Lm	521Lm
Minigrig 86 2S SP:	1796Lm	1764Lm	1743Lm	1871Lm	1837Lm	1815Lm	1929Lm	1894Lm	1872Lm	1041Lm
Minigrig 86 S MP:	1538Lm	1558Lm	1748Lm	1608Lm	1629Lm	1828Lm	1667Lm	1688Lm	1894Lm	
Minigrig 86 2S MP:	3076Lm	3116Lm	3496Lm	3217Lm	3259Lm	3656Lm	3334Lm	3377Lm	3789Lm	
Minigrig 86 S HP:	2136Lm	2164Lm	2428Lm	2234Lm	2263Lm	2539Lm	2315Lm	2345Lm	2631Lm	
Minigrig 86 2S HP:	4272Lm	4329Lm	4859Lm	4467Lm	4526Lm	5078Lm	4629Lm	4690Lm	5262Lm	

MINIGRID 86 SP

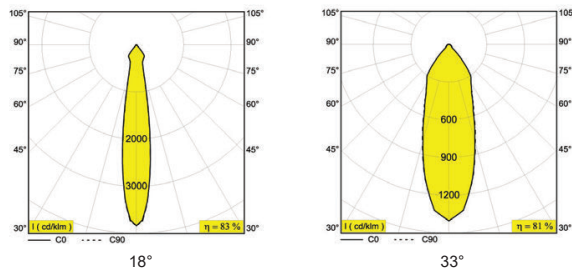

MINIGRID 86 SOFT DIM

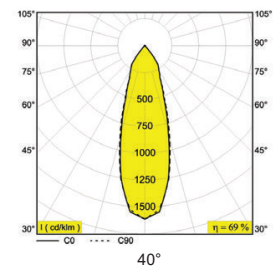

MINIGRID 86 MP/HP

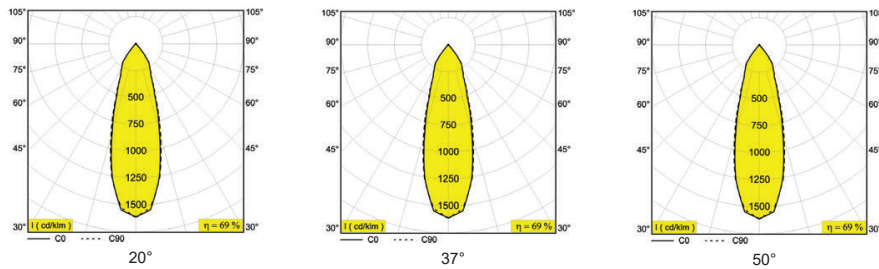

Installation Options

IC AIRTIGHT (With Shape S Power SP)

S-SMALL:
A:15"-7/16 x **B:**8"-11/16 x **C:**5"
A:393mm x **B:**220mm x **C:**127mm

- Low Profile 5" Height
- New Construction Airtight
- For use in insulated ceiling
- Chicago Plenum
- ETL Listed
- Hangerbar expand to 26" - reduce to 14"-3/16
- Damp rated

IC AIRTIGHT (With Shape 2S Power SP)

M-Medium:
A:14"-1/4 x **B:**11"-1/16 x **C:**6"-7/8
A:362mm x **B:**281mm x **C:**174mm

- Medium Profile 6"-7/8 Height
- New Construction Airtight
- For use in insulated ceiling
- Chicago Plenum
- ETL Listed
- Hangerbar expand to 24"-23/32 or 15"-3/32 - reduce to 12"-23/32 or 9"-1/32
- Damp rated



NON-IC PLASTERFRAME

S-SMALL:
A:12"-23/32 x **B:**11"-1/16 x **C:**5"
A:323mm x **B:**281mm x **C:**127mm

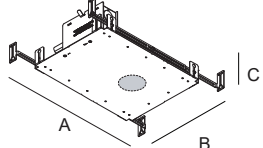

-
-
-
- ETL Listed
- Hangerbar expand to 24"-23/32 or 15"-3/32 - reduce to 12"-23/32 or 9"-1/32
- Damp rated
- Voltage dedicated (120V or 277V)

Driver Options

D1

- Dimming Control 0-10V
- Dimming Range 1-100%
- Dim to off yes at 0.8V, 1V, 1.2V, or N/A
- Power Factor @ Full Load >0.9 under 120Vac Input with 80~100% load condition (for all output currents)
- Efficiency @ Full Load ≥86
- THD @ Full Load <20% under 120Vac input with 80~100% load condition (for all output currents)

Dimmer Compatibility

- Leviton IP710-LFZ / IP710-DLX
- Lutron DDTV/DVSTV/DVSCTV/DVSCSTV

D1 (With Shape 2S)

- Dimming Control 0-10V
- Dimming Range 1-100%
- Dim to off yes at 0.7mA
- Power Factor @ Full Load >0.9
- Efficiency @ Full Load ≥87
- THD @ Full Load <20%
- Title 24 Compliant

Dimmer Compatibility

- Leviton IP710-DLZ
- Lutron DDTV-XX
- WattStopper ADF-120277
- Synergy Lighting Controls ISD BC

D8

- Dimming Control Phase Control
- Dimming Range 10-100%
- Dim to off no
- Power Factor @ Full Load >0.9
- Efficiency @ Full Load ≥80
- THD @ Full Load <5%

Dimmer Compatibility

- Leviton IPE04-1LZ
- Lutron DVELV-300P

D8 (With Shape 2S)

- Dimming Control Phase Control
- Dimming Range 20-100%
- Dim to off yes
- Power Factor @ Full Load >0.9
- Efficiency @ Full Load ≥80
- THD @ Full Load <10%

Dimmer Compatibility

- Leviton IPE04-1LZ
- Lutron DVELV-300P

As technology changes, please use information above as guidance. For most recent updated information please contact factory. Specifications subject to change without notice.

