



Fixture Type
Materials
Finish

Interior linear strip
Aluminium
White
*consult factory for other finishes

Lamp Type
Lamp Quantity
Lamp Included
Wattage
Input Voltage
Delivered Lumens
Kelvin
CRI
Power S Type
Power S Quantity
Power S Location
Dimming Type

LED
n/a
Yes
3.2 W/ft
24 VDC
272 lm/ft
2700 K
95
Driver
Up to 24 ft
Remote
ELV

Designer

Core

Listings

UL
JA8 Listed
WET

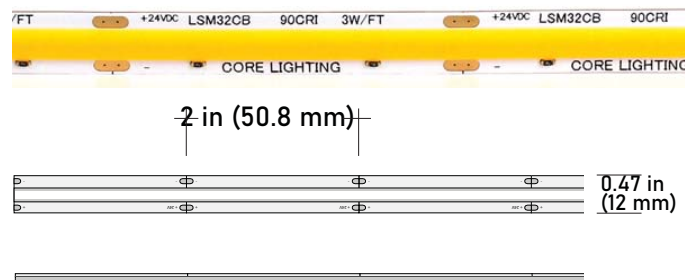
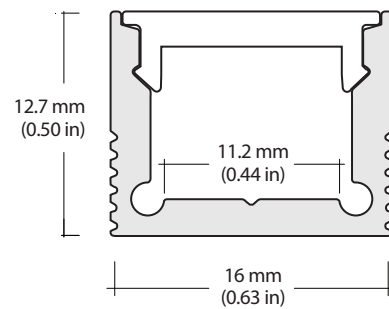



FEATURES

- Customizable
- Durable, anodized aluminum
- Protects LED systems from dust and other elements
- Slim, low profile design
- Dissipates heat from LED, prolonging its lifetime

SPECIFICATIONS

| | |
|----------------------------------|------------------------|
| TYPE | Surface mount |
| AVAILABLE LENGTHS | 49.25", 84" and 98.5" |
| FINISH | Silver / Black / White |
| LENS OPTIONS | Frosted |
| CHANNEL | ALP-60 |
| LENS | ALP-60-LN |
| END CAP | ALP-60-EC |
| MOUNTING CLIPS | ALP-60-CL |
| ADJUSTABLE BRACKET (TALL) | ALP-60-BKT-ADJ |
| ADJUSTABLE BRACKET | ALP-60-ASB |

WEIGHT 5.33 lbs
Compatible with LED strips up to 12mm (0.48") wide.

LED tape light sold separately.

Frosted Lens diffuser included with every profile

2 (two) end caps included with every channel.

Custom color finishes available (powder-coating).

98" profile NOT available in black



STANDARD ORDERING CODE

| Model | Length | Lens | Light Engine | Finish |
|-------|---------------------|----------------------|----------------|--------------------------------------|
| ALP60 | 49 49.25" | FR Frosted | See P.3 | SI Silver |
| | 84 84" | | | WH White |
| | 98 98.5" | | | BK Black |
| | | | | CU Custom (powder-coat) |

NOTE: Custom color finishes require powder coating. Allow 7 days lead time.

98" profile NOT available in black



COMPONENTS AND ACCESSORIES

ALP-60 | Aluminum Profile

MOUNTING LENGTHS Surface
49.25" and 98.5"

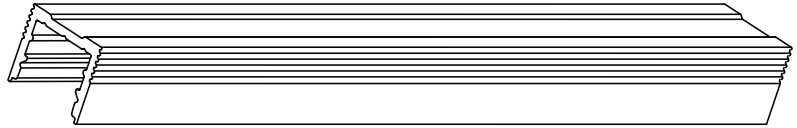

ALP-60LN | Lens Cover

TYPE Frosted (included)
LENGTHS 49.25" and 98.5"

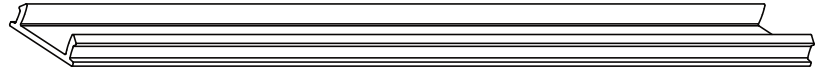

ALP-60EC | End Cap

Two end caps included with every profile

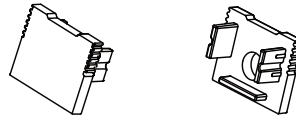

ALP-60CL | Metal Mounting Clips

Two end caps included with every profile

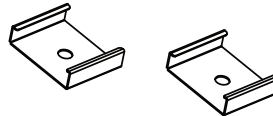

ALP-60-BKT-ADJ | Adjustable Bracket

* optional item (sold separately)

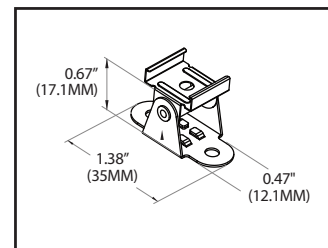
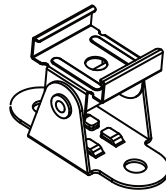





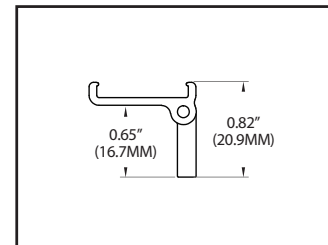
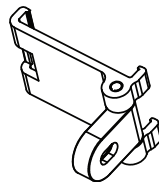

ALP-60-ASB | Adjustable Bracket



* optional item (sold separately)



SPECIFICATIONS



| | |
|------------------------------|--|
| INPUT VOLTAGE | 24V DC |
| POWER CONSUMPTION | 3.2 per foot |
| LUMEN OUTPUT | (27K) 272 Lm/Ft. (30K) 292 Lm/Ft. (40K) 297 Lm/Ft. |
| BEAM ANGLE | 180° |
| CRI | 90+ |
| DIMMING | MLV, ELV, 0-10 and TRIAC |
| MAXIMUM RUN LENGTH | 16.4 Feet |
| FIELD CUTTABLE | Every 2 in |
| IP RATING | IP65 wet location (outdoor) |
| LUMEN MAINTENANCE | 50,000 hrs. |
| OPERATING TEMPERATURE | -40°F(-40°C)~+140°F(+60°C) |
| BINNING | 2 Step Macadam Ellipse |
| CERTIFICATIONS | UL listed, TITLE 24 JA8 |
| DIMENSIONS | 0.4" x 0.08 (width x height) |
| WARRANTY | 5 Years |

FEATURES

- 3.2W per Foot
- 90+ CRI
- California TITLE 24 JA8 compliant
- Field cuttable
- Suitable for accent or ambient lighting
- 27K, 30K and 40K CCT options available
- Available in 24V
- UL Listed
- Dimmable with CORE Lighting dimmable drivers
- Approved for closet / storage space installation per NEC 410.16(A)(3) and 410.16(C)(5)

| | COLOR TEMP | CRI | LUMEN/FT |
|---|------------|-----|----------|
|  | 2700K | 90 | 272 |
|  | 3000K | 90 | 292 |
|  | 4000K | 90 | 297 |

STANDARD ORDERING CODE

| Model | Color Temp | Length | Voltage | Profile | NOTE: |
|----------|--------------|----------------|----------------|---------------------|---|
| LSMW32CB | 27K 2700K | 16 16.4 Ft. | 24 24 Volts | ²See p3 for options | <p>1 = Custom length per Ft. cuttable every 2"</p> <p>2 = Custom color finishes require powder coating. Allow 7 days lead time.</p> |
| | 30K 3000K | 1XX per Ft. | | | |
| | 40K 4000K | | | | |



SPECIFICATION SHEET



PSDL SERIES indoor/outdoor drivers are highly efficient, stable with smooth dimming capability compatible with most TRIAC, ELV, MLV, reverse and forward phase dimmers, and on/off switches. These drivers are derated allowing them to be loaded to maximum wattage capacity.

FEATURES

- High power factor/efficiency
- Short circuit and over current protection
- 100~277V AC for any residential or commercial application
- Superior PWM dimming technology
- Factory derated
- Only 10% minimum load
- Compatible with TRIAC, MLV and ELV dimmers
- Flicker-free dimming

INPUT

| | |
|-----------------------|--------------------------------|
| INPUT VOLTAGE RANGE | 100~277V AC |
| INPUT FREQUENCY RANGE | 47~63 Hz |
| POWER FACTOR (AVG.) | ≥0.98 (120VAC); ≥0.96 (277VAC) |
| AC CURRENT (MAX.) | 1.3A (100V AC) |
| INRUSH CURENT | 20A, 50%, 1.6ms |
| LEAKAGE CURRENT | <0.5mA |

OUTPUT

| | |
|---------------------------|--------|
| OUTPUT VOLTAGE | 24V DC |
| OUTPUT CURRENT @ MAX LOAD | 4A |
| OUTPUT MAX WATTAGE | 96W |
| MINIMUM LOAD | 10% |
| MAXIMUM LOAD | 100% |

ADDITIONAL SPECIFICATIONS

| | |
|--------------------------|-----------------------------|
| ENVIRONMENT | Outdoor Rated IP65 |
| DIMMING | ELV, MLV & TRIAC |
| SHORT CIRCUIT | Short Circuit auto recovery |
| WIRE TERMINAL CONNECTION | Fits up to 12AWG |
| HOUSING / COOLING | Free-air convection |

SPECIFICATIONS

| | |
|-----------------------|------------------------------|
| CLASS 2 | YES |
| LOAD REGULATION | 2% |
| LINE REGULATION | 5% |
| INPUT FREQUENCY | 47~63 Hz |
| POWER FACTOR | >0.92 |
| EFFICIENCY | >83% |
| MTBF | 50,000 hrs. |
| OPERATING ENVIRONMENT | -40°F ~ 140°F (-40°C ~ 60°C) |
| FUNCTION SURFACE TEMP | -40 to +80 (25 C AMB) |
| STORAGE TEMPERATURE | -40°F ~ 176°F (-40°C ~ 80°C) |
| HUMIDITY | 20~90% RH, non condensing |
| LENGTH | 8.67" (220.2MM) |
| WIDTH | 3.67" (93.2MM) |
| HEIGHT | 1.62" (41.1MM) |

MISC

| | |
|-------------------|---------------------|
| SAFETY STANDARDS | UL-8750, UL 1310 |
| WITHSTAND VOLTAGE | I/P-O/P : 1.88KV AC |
| EMC EMISSION | FCC Part 15 B |
| WARRANTY | 5 year Limited |

